

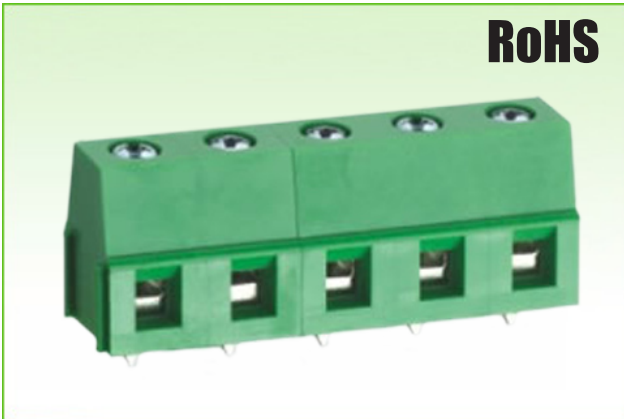

7.5mm Pitch



		
Rated Voltage	300V	250V
Rated Current	20A	12A
Insulation Withstand Voltage	AC 2000V / Min.	
Insulation Resistance	500MΩ or More at DC500V	
Temperature Range	-40°C to +105°C	
Screw Torque	0.4N.m	
Wire Range	12-24AWG	2.5mm ²

Units: mm

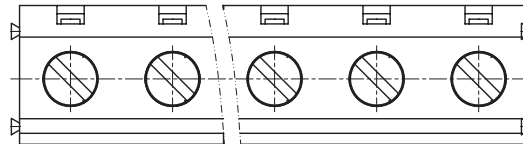
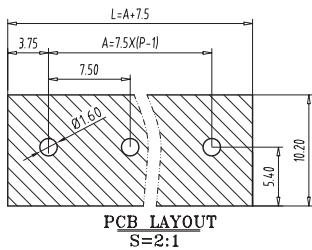

- ① Housing: PA66(V0)
- ② Block: Brass, Nickel Plated
- ③ Solder Pin: Brass, Tin Plated
- ④ Screw: Steel, Zinc Plated

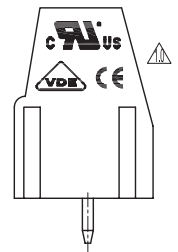
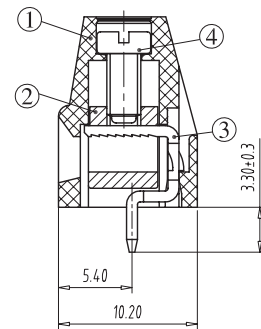
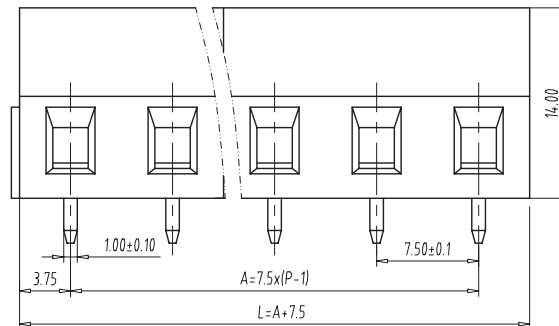
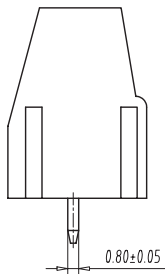

Part Numbering System:

102-750V - XXP - XXX

① ② ③

① Series

② Number of Poles: 02, 03, 04, ..., 24

③ Insulator Color: GRN = Green

# Pin	2	3	4	5	6	7	8	9	10	11	12	13
Dim L	15.0	22.5	30.0	37.5	45.0	52.5	60.0	67.5	75.0	82.5	90.0	97.5
Dim A	7.5	15.0	22.5	30.0	37.5	45.0	52.5	60.0	67.5	75.0	82.5	90.0
# Pin	14	15	16	17	18	19	20	21	22	23	24	
Dim L	105.0	112.5	120.0	127.5	135.0	142.5	150.0	157.5	165.0	172.5	180.0	
Dim A	97.5	105.0	112.5	120.0	127.5	135.0	142.5	150.0	157.5	165.0	172.5	