

## Part No: 3-29B-WC2D

### Features:

- ◇ Standard T-1 ( $\Phi$ 3mm) package.
- ◇ Fast response time.
- ◇ High photo sensitivity.
- ◇ Small junction capacitance.
- ◇ The product itself will remain within RoHS compliant Version.

### Descriptions:

- ◇ This is a high speed and high sensitive silicon NPN phototransistor in a standard T-1 ( $\Phi$ 3mm) epoxy package.
- ◇ Due to its clear epoxy, the device is matched to visible light and infrared radiation.

### Applications:

- ◇ Infrared applied system.
- ◇ Counters and sorters.
- ◇ Encoders.
- ◇ Floppy disk drive.
- ◇ Optoelectronic switch.
- ◇ Video camera, tape and card readers.
- ◇ Position sensors.

## Part No: 3-29B-WC2D

### Package Dimension:

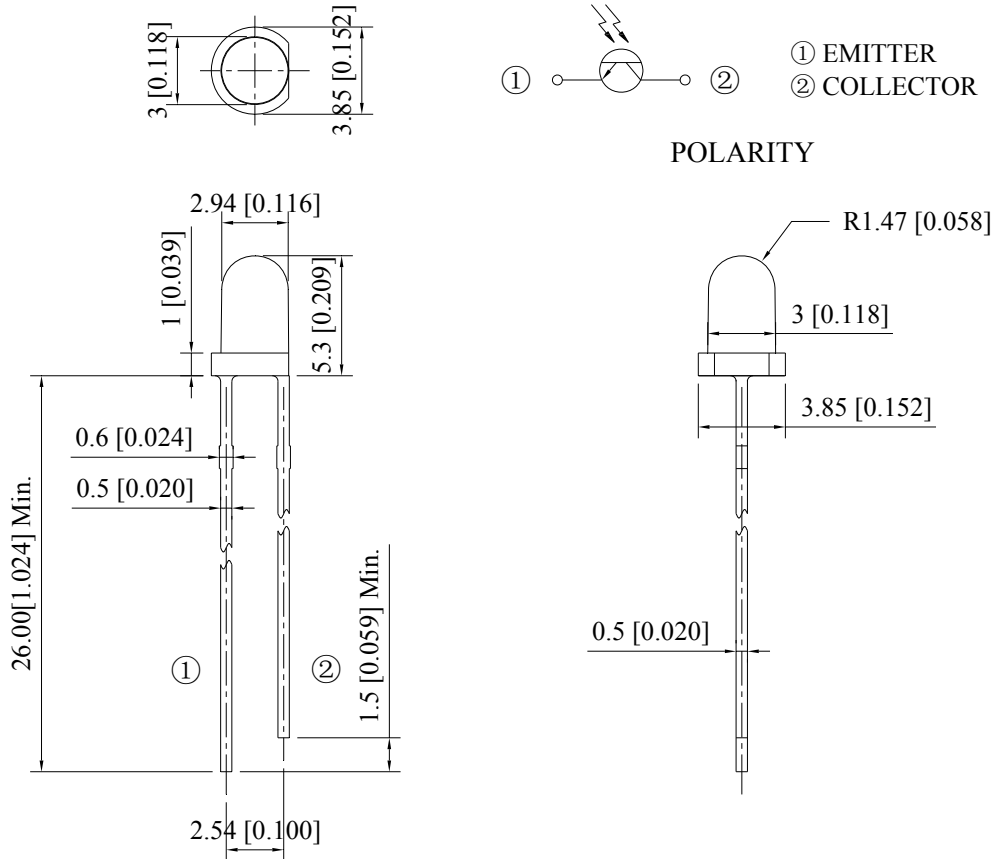

Part No.	Chip Material	Lens Color	Source Color
3-29B-WC2D	Silicon	Water Clear	Phototransistor

### Notes:

1. All dimensions are in millimeters (inches).
2. Tolerance is  $\pm 0.25$  mm (.010") unless otherwise noted.
3. Protruded resin under flange is 1.00 mm (.039") max.
4. Specifications are subject to change without notice.

## Part No: 3-29B-WC2D

### Absolute Maximum Ratings (Ta=25°C)

Parameters	Symbol	Rating	Unit
Power Dissipation at (or below) 25°C free Air Temperature	$P_D$	75	mW
Collector-Emitter Voltage	$V_{CEO}$	30	V
Emitter-Collector-Voltage	$V_{ECO}$	5	V
Collector Current	$I_C$	20	mA
Electrostatic Discharge (HBM)	ESD	2000	V
Operating Temperature	$T_{opr}$	-40 to +80	°C
Storage Temperature	$T_{stg}$	-40 to +85	°C
Lead Soldering Temperature [4mm (.157") From Body]	$T_{sol}$	260°C	°C

### Electrical Optical Characteristics at Ta=25°C

Parameters	Symbol	Min.	Typ.	Max.	Unit	Condition
Collector-Emitter Breakdown Voltage	$BV_{CEO}$	30	---	---	V	$I_C=100\mu A$ , $E_e=0mW/cm^2$
Emitter-Collector Breakdown Voltage	$BV_{ECO}$	5	---	---	V	$I_e=100\mu A$ , $E_e=0mW/cm^2$
Collector-Emitter Saturation Voltage	$V_{CE(SAT)}$	---	---	0.40	V	$I_C=0.70mA$ , $E_e=1mW/cm^2$
Optical Rise Time (10% to 90%)	$T_R$	---	15	---	ns	$V_{CE}=5V$ , $I_C=1mA$ , $R_L=1000\Omega$
Optical Fall Time (90% to 10%)	$T_F$	---	15	---		
Collector Dark Current	$I_{CEO}$	---	---	100	nA	$E_e=0mW/cm^2$ , $V_{CE}=20V$
On State Collector Current	$I_{C(ON)}$	0.50	2.50	---	mA	$E_e=1mW/cm^2$ , $V_{CE}=5V$
Reception Angle	$2\theta_{1/2}$	---	20	---	Deg	
Wavelength Of Peak Sensitivity	$\lambda_P$	---	940	---	nm	
Rang Of Spectral Bandwidth	$\lambda_{0.5}$	400	---	1100	nm	

## Part No: 3-29B-WC2D

Typical Electrical / Optical Characteristics Curves  
(25°C Ambient Temperature Unless Otherwise Noted)

Spectral Sensitivity

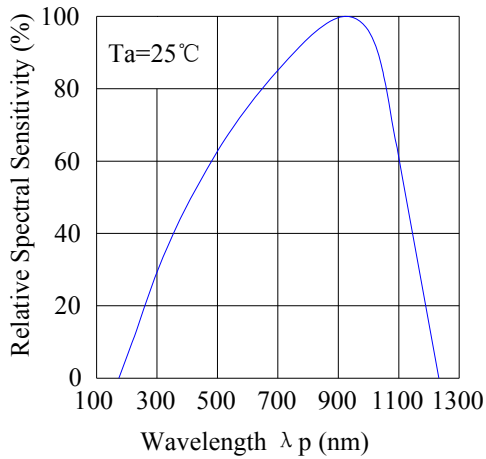

Collector Current & Irradiance

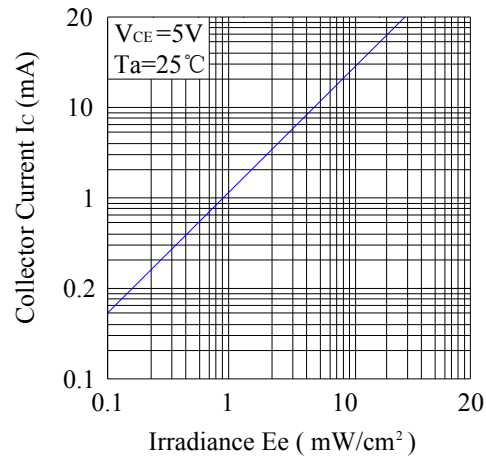

Relative Collector Current & Ambient Temperature

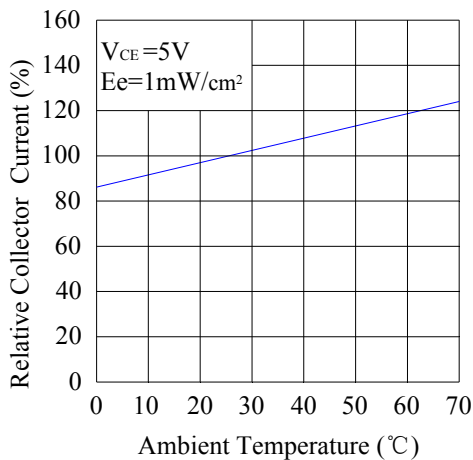

Collector Power Dissipation & Ambient Temperature

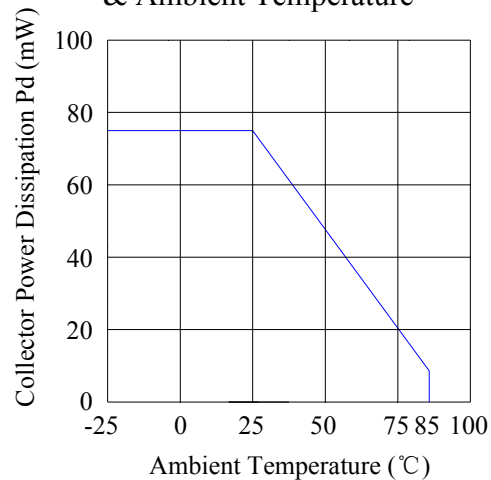

Collector Dark Current & Ambient Temperature

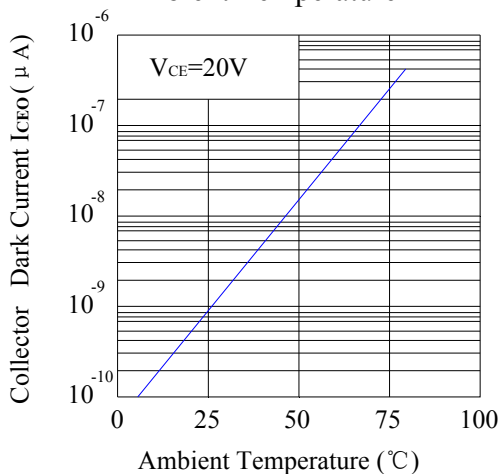

Collector Current & Collector-Emitter Voltage

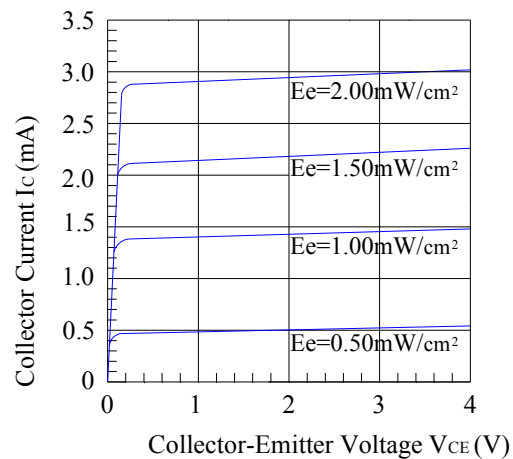

## Part No: 3-29B-WC2D

### Reliability Test Item And Condition:

The reliability of products shall be satisfied with items listed below:

Confidence level: 90%.

LTPD: 10%.

No.	Item	Test Conditions	Test Hours/ Cycles	Sample Sizes	Failure Judgment Criteria	Ac/ Re
1	Reflow Soldering	TEMP.: 260°C±5°C 5secs	6mins	22pcs	$I_{C(ON)} \leq L \times 0.8$  L: Lower Specification Limit	0/1
2	Temperature Cycle	H: +100°C 15mins ↑ 5 mins ↓ L: -40°C 15mins	50Cycles	22pcs		0/1
3	Thermal Shock	H: +100°C 15mins ↑ 10mins ↓ L: -10°C 5mins	50Cycles	22pcs		0/1
4	High Temperature Storage	TEMP.: +100°C	1000hrs	22pcs		0/1
5	Lower Temperature Storage	TEMP.: -40°C	1000hrs	22pcs		0/1
6	DC Operating Life	$V_{CE}=5V$	1000hrs	22pcs		0/1
7	High Temperature/ High Humidity	85°C / 85% R.H	1000hrs	22pcs		0/1

## Part No: 3-29B-WC2D

Please read the following notes before using the product:

### 1. Over-current-proof

Customer must apply resistors for protection, otherwise slight voltage shift will cause big current change (Burn out will happen).

### 2. Storage

2.1 Do not open moisture proof bag before the products are ready to use.

2.2 Before opening the package, the LEDs should be kept at 30°C or less and 80%RH or less.

2.3 The LEDs should be used within a year.

2.4 After opening the package, the LEDs should be kept at 30°C or less and 60%RH or less.

2.5 The LEDs should be used within 168 hours (7 days) after opening the package.

### 3. Soldering Iron

Each terminal is to go to the tip of soldering iron temperature less than 260°C for 5 seconds within once in less than the soldering iron capacity 25W. Leave two seconds and more intervals, and do soldering of each terminal. Be careful because the damage of the product is often started at the time of the hand solder.

### 4. Soldering

When soldering, for Lamp without stopper type and must be leave a minimum of 3mm clearance from the base of the lens to the soldering point.

To avoided the Epoxy climb up on lead frame and was impact to non-soldering problem, dipping the lens into the solder must be avoided.

Do not apply any external stress to the lead frame during soldering while the LED is at high temperature.

Recommended soldering conditions:

Soldering Iron		Wave Soldering	
Temperature	300°C Max.	Pre-heat	100°C Max.
Soldering Time	3 sec. Max. (one time only)	Pre-heat Time	60 sec. Max.
		Solder Wave	260°C Max.
		Soldering Time	5 sec. Max.

Note: Excessive soldering temperature and / or time might result in deformation of the LED lens or catastrophic failure of the LED.

### 5. Repairing

Repair should not be done after the LEDs have been soldered. When repairing is unavoidable, a double-head soldering iron should be used (as below figure). It should be confirmed beforehand whether the characteristics of the LEDs will or will not be damaged by repairing.

### 6. Caution in ESD

Static Electricity and surge damages the LED. It is recommended to use a wrist band or anti-electrostatic glove when handling the LED. All devices equipment and machinery must be properly grounded.