



Housing: Die-Cast Aluminum, Painted Black  
 Blade: Thermoplastic PBT, UL 94V-0  
 Insulation Resistance: 100M $\Omega$ , 500VDC/min between bare wire and frame  
 Dielectric Strength: 1500VAC for one minute  
 Operation Temperature: -10°C-70°C(Humidity 35%-85%RH)  
 Storage Temperature: -40°C-85°C(Humidity 35%-85%RH)  
 Motor Protection: Thermal Protected  
 Weight: 920 g

**AC AXIAL FAN**  
**172x150x51 mm**



SS

Model Number	Voltage (VAC)	Frequency (Hz)	AirFlow (CFM)	Stat.Pres. (mm-H <sub>2</sub> O)	Noise (dBA)	Speed (RPM)	Current (mA)	Power (W)	Available Bearing	Curves
FA1751B11T7C-91	115	50/60	213.2/243.6	14.7/18.6	49.3/56.1	2,850/3,400	250/220	27/28	B	①/②
FA1751B22T7C-91	230	50/60	213.2/243.6	14.7/18.6	49.3/56.1	2,850/3,400	130/110	25/24	B	①/②

• For "Wire Lead" version, change the "T" in the model number to "W".

Specifications are subject to change without notice

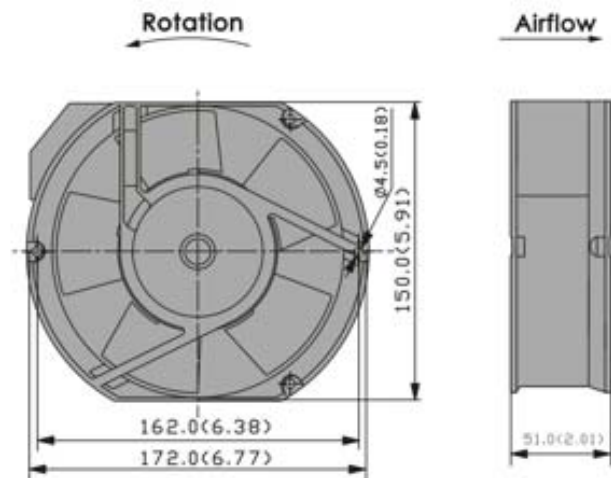
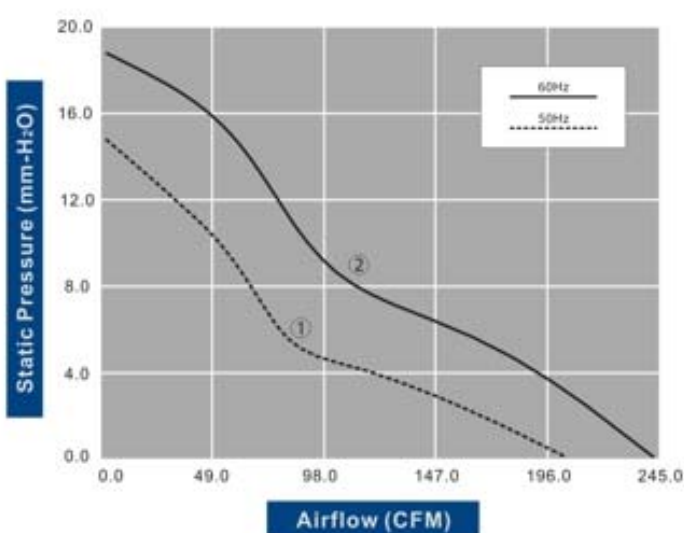

unit: mm(inch)