

SURFACE MOUNT GENERAL RECTIFIER

Features

- The plastic package carries Underwriters Laboratory Flammability Classification 94V-0
- Idea for printed circuit board
- Glass passivated Junction chip
- Low reverse leakage
- High forward surge current capability
- High temperature soldering guaranteed 250 C/10 seconds at terminals

Mechanical Data

Case : JEDEC DO-214AC/SMA Molded plastic body

Terminals : Solder plated, solderable per MIL-STD-750,Method 2026

Polarity : Polarity symbol marking on body

Mounting Position : Any

Weight : 0.00 19ounce, 0.0 55 grams

DO-214AC/SMA

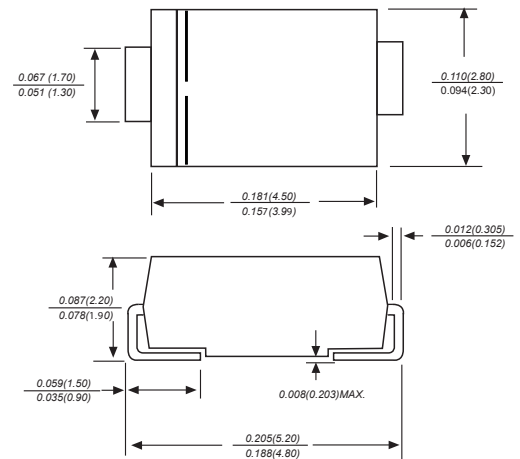

Dimensions in inches and (millimeters)

Maximum Ratings And Electrical Characteristics

Ratings at 25°C ambient temperature unless otherwise specified.

Single phase half-wave 60Hz, resistive or inductive load, for capacitive load current derate by 20%.

Parameter	SYMBOLS	M1	M2	M3	M4	M5	M6	M7	UNITS
Marking Code									
Maximum repetitive peak reverse voltage	V_{RRM}	50	100	200	400	600	800	1000	V
Maximum RMS voltage	V_{RMS}	35	70	140	280	420	560	700	V
Maximum DC blocking voltage	V_{DC}	50	100	200	400	600	800	1000	V
Maximum average forward rectified current	$I_{(AV)}$	1							A
Peak forward surge current 8.3ms single half sine-wave superimposed on rated load	I_{FSM}	30							A
Maximum instantaneous forward voltage at 1.0A	V_F	1.1							V
Maximum DC reverse current $T_A=25^\circ C$ at rated DC blocking voltage $T_A=125^\circ C$	I_R	5 50							μA
Typical junction capacitance (NOTE 1)	C_J	15							pF
Typical thermal resistance (NOTE 2)	$R_{\theta JA}$	75							$^\circ C/W$
Operating junction and storage temperature range	T_J, T_{STG}	-55 to +150							$^\circ C$

Note: 1. Measured at 1MHz and applied reverse voltage of 4.0V D.C.
2. P.C.B. mounted with 2.0x2.0" (2.54 x2.54cm) copper pad areas

Ratings And Characteristic Curves

Fig.1 Forward Current Derating Curve

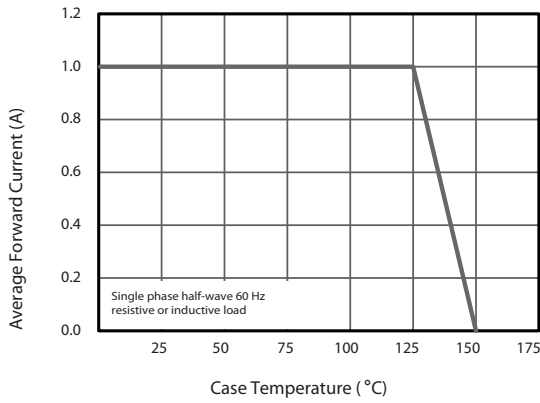

Fig.2 Typical Instaneous Reverse Characteristics

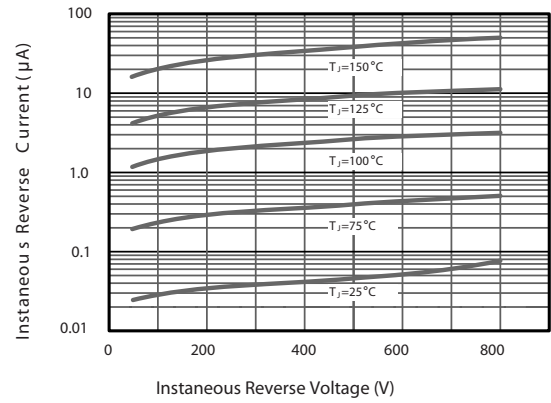

Fig.3 Typical Forward Characteristic

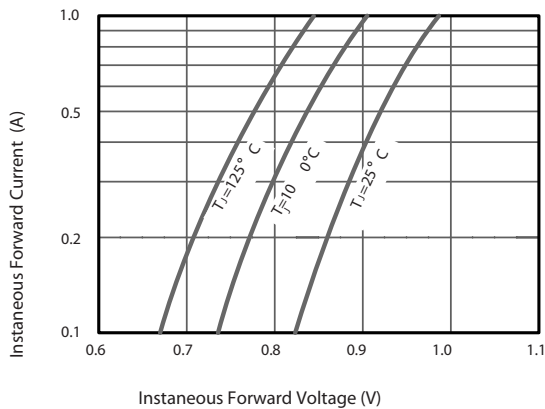

Fig.4 Typical Junction Capacitance

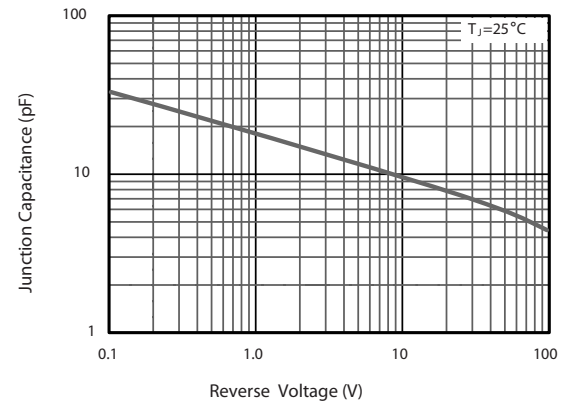
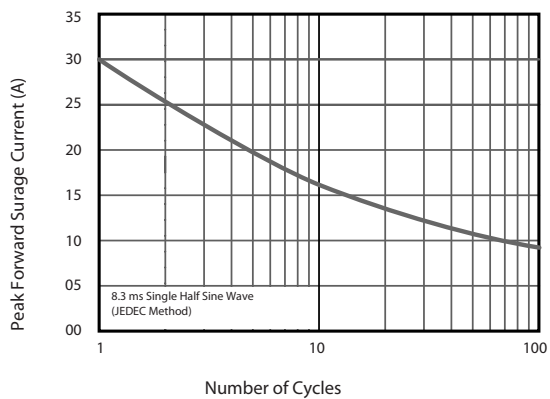
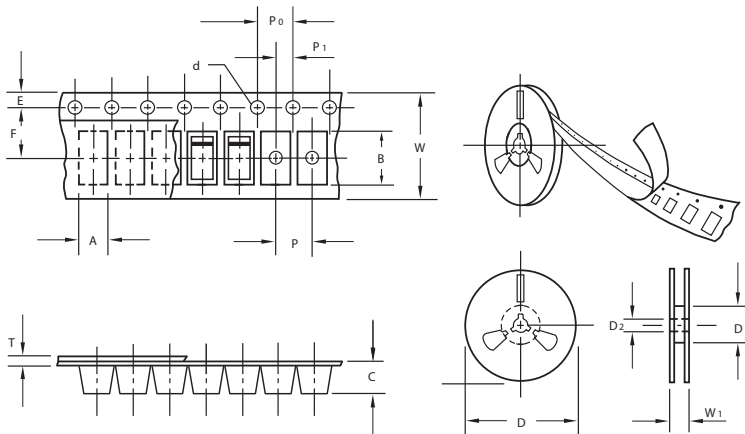

Fig.5 Maximum Non-Repetitive Peak Forward Surage Current



The curve above is for reference only.

Packing information



unit:mm

Item	Symbol	Tolerance	SMA
Carrier width	A	0.1	2.80
Carrier length	B	0.1	5.33
Carrier depth	C	0.1	2.36
Sprocket hole	d	0.05	1.50
13" Reel outside diameter	D	2.0	330.00
13" Reel inner diameter	D ₁	min	50.00
7" Reel outside diameter	D	2.0	178.00
7" Reel inner diameter	D ₁	min	62.00
Feed hole diameter	D ₂	0.5	13.00
Sprocket hole position	E	0.1	1.75
Punch hole position	F	0.1	5.50
Punch hole pitch	P	0.1	4.00
Sprocket hole pitch	P ₀	0.1	4.00
Embossment center	P ₁	0.1	2.00
Overall tape thickness	T	0.1	0.28
Tape width	W	0.3	12.00
Reel width	W ₁	1.0	18.00

Note: Devices are packed in accordance with EIA standard RS-481-A and specifications listed above.

Reel packing

PACKAGE	REEL SIZE	REEL (pcs)	COMPONENT SPACING (m/m)	BOX (pcs)	INNER BOX (m/m)	REEL DIA, (m/m)	CARTON SIZE (m/m)	CARTON (pcs)	APPROX. GROSS WEIGHT (kg)
SMA	7"	2,000	4.0	4,000	183*155*183	178	382*356*392	80,000	16.0
SMA	11"	5,000	4.0	10,000	290*290*38	330	310*310*360	80,000	11.0
SMA	13"	7,500	4.0	15,000	335*335*38	330	350*330*360	120,000	14.5

Suggested Pad Layout



Symbol	Unit (mm)	Unit (inch)
A	1.68	0.066
B	1.52	0.060
C	3.90	0.154
D	2.41	0.095
E	5.45	0.215